

TRACKS



VECTOR TRACKS



ANTHRACITE - ANT



BLACK - BLA



BRUSHED ALUMINIUM - BA



SATIN SILVER - SS

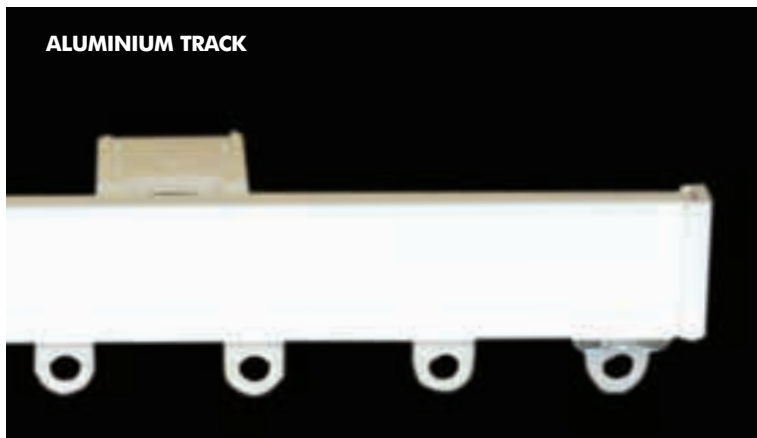

ALUMINIUM TRACK



H772LLS4



H772J



H772G



H772EC

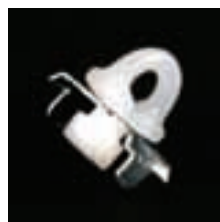

H772TE

VECTOR TRACKS

H785/SIZE/COLOUR

Depth of profile: 25mm
Bracket projection: 40mm
Packaging: Jetran

- Aluminium available in four colours
- Siliconised gliders
- Colour co-ordinated fittings (uv resistant)
- Suitable for medium to heavy weight curtains
- 4cm Wall and ceiling fix brackets

Sizes available:

150cm, 200cm, 250cm
All single lengths. Use with H772J for longer tracks

ALUMINIUM TRACK

H772(SIZE)

Depth of profile: 23mm
Bracket projection: 40mm
Packaging: Polythene bag

- White painted aluminium
- Siliconised gliders
- Nylon fittings (uv resistant)
- Suitable for medium to heavy weight curtains
- Bendable with fillers.
- Wall and ceiling fix brackets

Sizes available:

150cm, 200cm, 250cm
All single lengths. Use with H772J for longer tracks
Contract sizes: 300cm, 600cm
Minimum quantities: 3m lengths - 20pcs, 6m lengths - 10pcs
See page 82 for Contract details.

SWISH SUPREME GLIDE

SWA975W0(SIZE)G

Depth of profile: 28mm
 Bracket projection: 27mm
 Retail packaging: Clear acetate

- Durable aluminium uncorded track with roller gliders
- Quick release lever lock brackets
- Can be bent into bay windows, no tools required
- Trimmed to size

Available sizes: 125cm, 150cm, 175cm, 200cm, 225cm, 250cm, 300cm, 350cm, 400cm contract rail only - 500cm

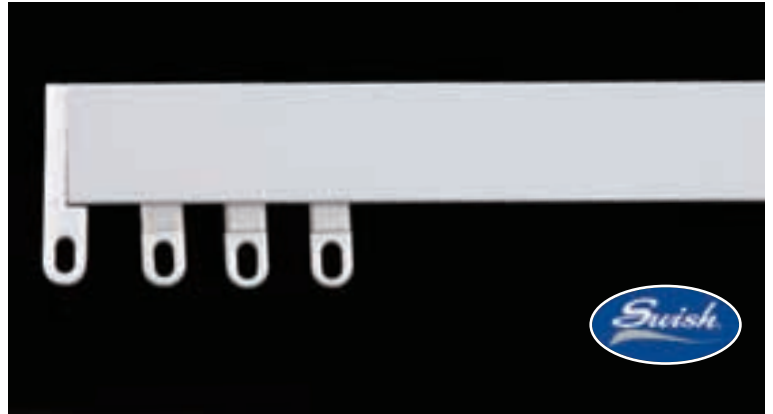

ALUGLIDE TRACK

IAGU00(SIZE)

Depth of profile: 30mm
 Bracket projection: 30mm
 Retail packaging: Clear acetate

- White painted aluminium track includes glide hooks
- Suitable for medium weight curtains
- Can be bent by hand and suitable for tight bends
- Wall and ceiling fix bracket

Sizes available: 100cm, 150cm, 180cm, 220cm, 270cm

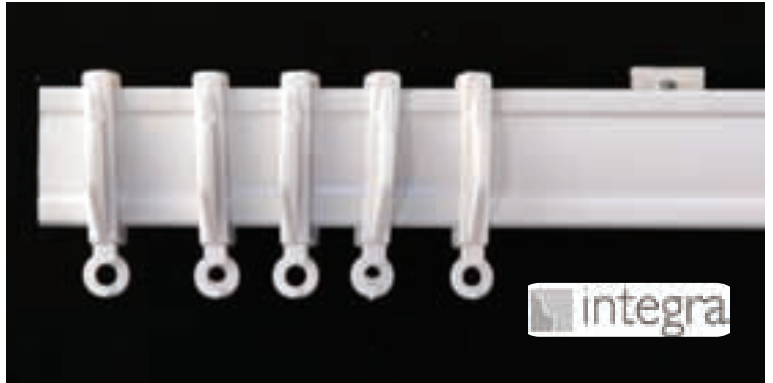

WHITE DRAPE

SW964(SIZE)W

Depth of profile: 19mm
 Bracket projection: 32mm
 Retail packaging: Shrink wrapped

- White painted aluminium track includes glide hooks
- Suitable for medium weight curtains
- Hand bendable
- Wall and ceiling fix brackets

Sizes available: 150cm, 180cm, 210cm, 240cm, 270cm
 Contract sizes: 300cm, 360cm, 420cm, 480cm

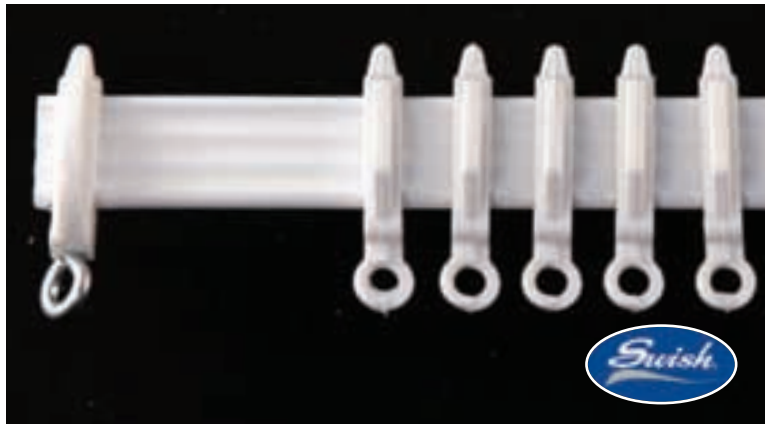

DISCREET TOP FIX

I07074(SIZE)

Depth of profile: 10mm
 Retail packaging: Clear acetate

- White Painted Aluminium
- Ready Assembled
- Nylon Button Slides
- Straight Runs and Top Fix only

Sizes available: 130cm, 190cm, 250cm, 310cm



DISCREET FACE FIX

I07073(SIZE)

Depth of profile: 18mm
 Retail packaging: Clear acetate

- White Painted Aluminium track comes ready assembled
- Nylon Button Slides
- Straight Runs and Face Fix only

Sizes available: 130cm, 190cm, 250cm, 310cm



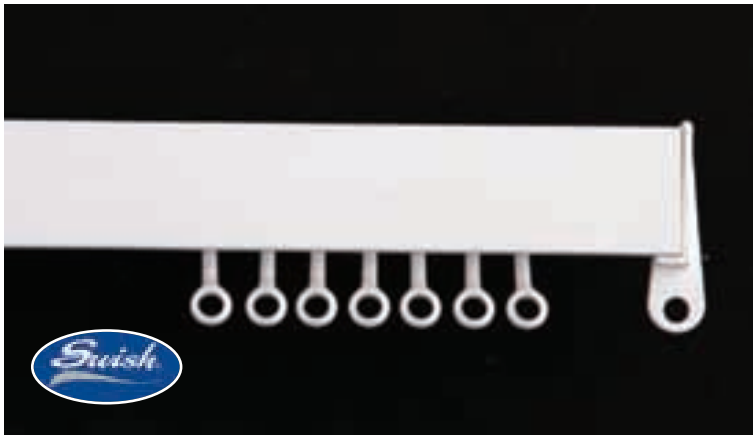

DELUXE

SWD100W0(SIZE)T

Depth of profile: 28mm
 Bracket projection: 27mm
 Retail packaging: Shrink wrapped

- White PVC
- Suitable for medium to heavy weight curtains
- Hand bendable
- Wall and ceiling fix brackets

Sizes available: 125cm, 150cm, 175cm, 200cm, 225cm, 250cm, 275cm

Contract sizes: 300cm, 375cm, 500cm

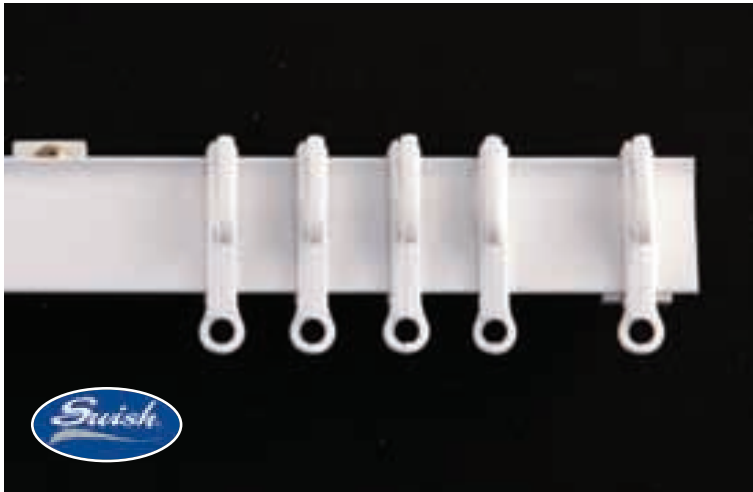

SOLOGLYDE

SWS100W0(SIZE)T

Depth of profile: 29mm
 Bracket projection: 34mm
 Retail packaging: Shrink wrapped

- White PVC
- Suitable for medium weight curtains
- Hand bendable
- Wall and ceiling fix brackets

Sizes available: 125cm, 150cm, 175cm, 200cm, 225cm, 250cm, 275cm

CONTRACT TRACK (only)

SWS101W(SIZE)T

300cm, 375cm, 500cm,

30m REELS

SWS101W300R

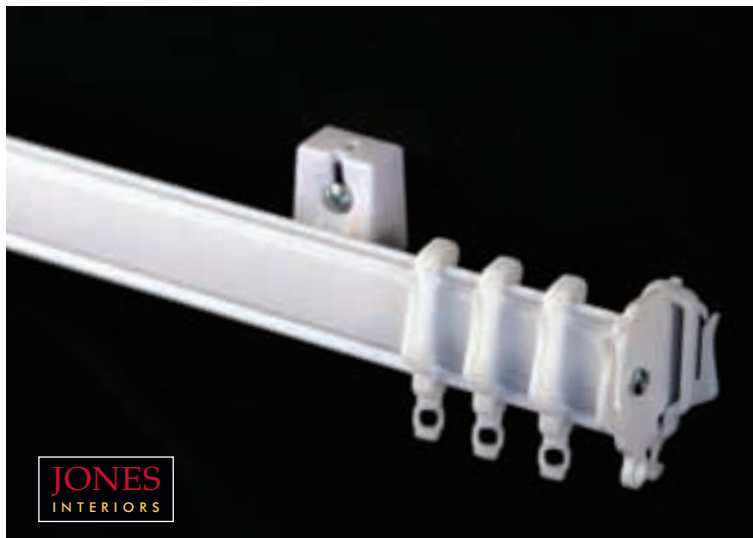

LASERGLIDE

H3041(SIZE)

Depth of profile: 32mm
 Bracket projection: 35mm
 Retail packaging: Shrink wrapped

- White PVC
- Acetal 'non snag' Glider Hooks
- Suitable for medium weight curtains
- Hand bendable
- Wall and ceiling fix bracket

Sizes available: 90cm, 120cm, 150cm, 180cm, 210cm, 240cm, 270cm

CONTRACT TRACK (only)

H3041T

500cm



NYLONGLYDE

SWN100(SIZE)T

Depth of profile: 15mm
 Bracket projection: 34mm
 Retail packaging: Shrink wrapped

- White PVC easy to fix
- Ideal behind pelmets and valances
- Suitable for straight and bay windows

Sizes available: 125cm, 150cm, 175cm, 200cm, 225cm, 250cm and 275cm

CONTRACT TRACK (only)

SW101(SIZE)T

300cm, 375cm and 500cm

Additional components available please see price list

ULTRAGLIDE

IULT00(SIZE)

Depth of profile: 26mm Bracket projection: 63-87mm
Retail packaging: Clear acetate

- White painted extendible steel comes ready-corded
- Easy fit silicon enriched gliders
- Suitable for heavy weight curtains
- Straight runs only
- Ball bearing end pulleys
- Wall and ceiling fix brackets

Sizes available: 100-175cm, 120-200cm, 175-300cm, 250-400cm, 300-550cm



SWANGLIDE 100-175CM

I02181

SWANGLIDE 175-300CM

I02182

SWANGLIDE 250-400CM

I02185

SWANGLIDE 300-550CM

I02183

Depth of profile: 20mm Bracket projection: 64-87mm
Retail packaging: Clear acetate

- White painted extendible steel comes ready corded
- Silicon enriched gliders
- Straight runs only for medium to heavyweight curtains
- Ball bearing end pulleys and wall & ceiling fix brackets

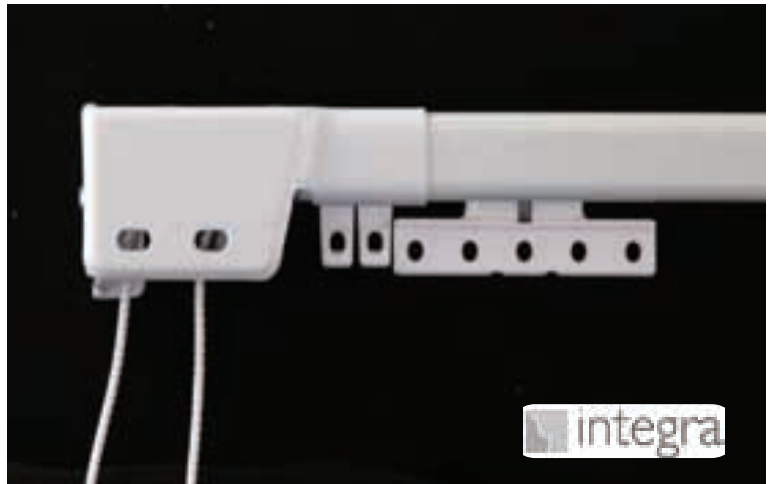

SUPREME CORD

SWA980W0(SIZE)G

Depth of profile: 28mm Bracket projection: 27mm
Retail packaging: Jetran

- High quality aluminium pre-corded track system
- Roller gliders
- Reversible overlap and underlap facility for light control
- Quick release lever lock brackets
- Can be bent into bay windows and trimmed to size

Sizes available: 150cm, 175cm, 200cm, 225cm, 250cm, 300cm*, 350cm*, 400cm* and 500cm*

Sizes do not include end pulleys

* Supplied in two halves with joiner

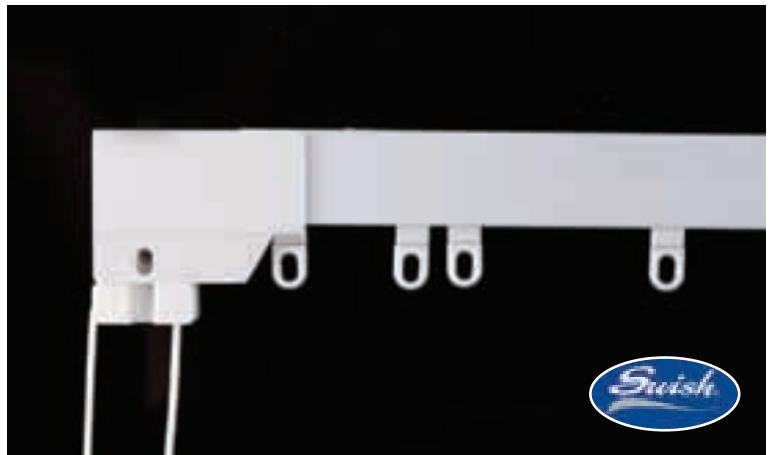

SUPERLUXE

SWL971W0(SIZE)G

Depth of profile: 28mm Bracket projection: 27mm
Retail packaging: Shrink wrapped

- White ready corded pvc complete with roller gliders
- Suitable for medium to heavy weight curtains
- Straight and bay windows
- Wall and ceiling fix leverlock brackets

Sizes available: 125cm, 150cm, 175cm, 200cm, 225cm, 250cm, 275cm, 300cm*, 350cm*, 375cm*, 425cm*, 500cm*

* Supplied in two halves with joiner

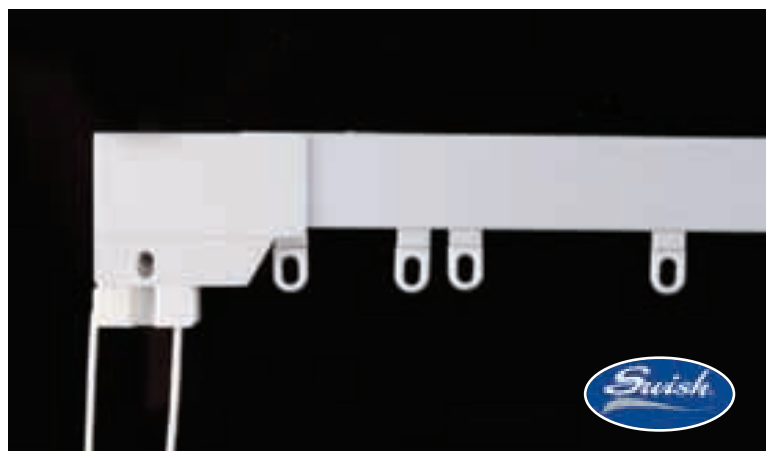

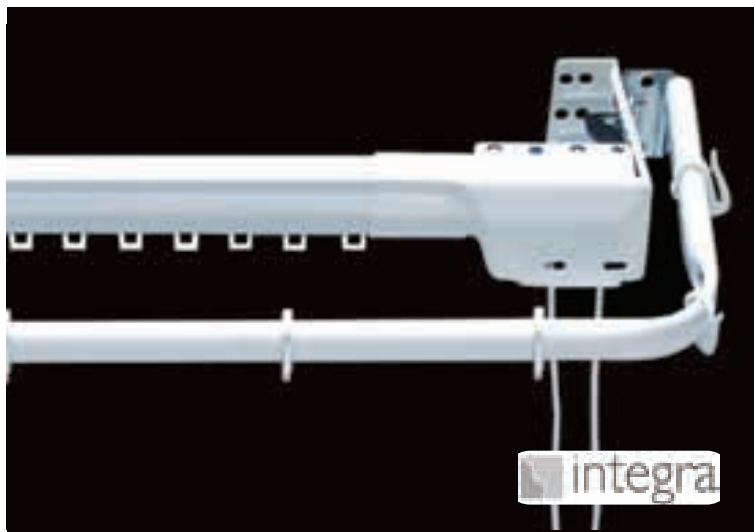

SUPER TWOSOME 100-175cm **I30081**

SUPER TWOSOME 175-300cm **I30082**

SUPER TWOSOME 250-400cm **I30085**

SUPER TWOSOME 300-550cm **I30086**

Depth of profile: 26mm
 Bracket projection: Track: 63-87mm Valance: 155-210mm
 Retail packaging: Clear acetate

- White painted extendible steel
- Ready corded
- Silicon enriched gliders
- Suitable for heavyweight curtains
- Straight runs only
- Ball bearing end pulleys
- Wall & ceiling fix brackets



TWOSOME 100-175cm **I20141**

TWOSOME 175-300cm **I20142**

TWOSOME 250-400cm **I20145**

TWOSOME 300-550cm **I20146**

Depth of profile: 20mm
 Bracket projection: Track: 64-90mm Valance: 155-210mm
 Retail packaging: Clear acetate



DUO TRACK **SWL500W0(SIZE)G**

Depth of profile: 28mm
 Bracket projection: Track: 60mm Valance: 140mm
 Retail packaging: Clear acetate

- White ready corded pvc
- Roller gliders
- Suitable for heavy weight curtains
- Includes valance hooks
- Straight and bay windows
- Hand bendable
- Wall and ceiling fix brackets

Sizes available: 125cm, 150cm, 175cm, 200cm, 225cm, 250cm, 275cm, 300cm*, 350cm*, 375cm*, 425cm*, 500cm*
 * Supplied in two halves with joiner

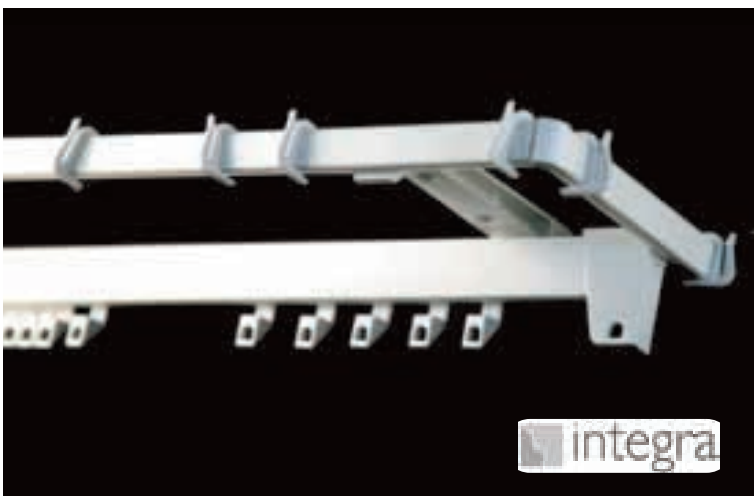

PREMIER TOP TWO **IPTT00(SIZE)**

Depth of profile: 28mm
 Bracket projection: Track: 40mm Valance: 140mm
 Retail packaging: Clear acetate

- White pvc
- Suitable for medium to heavy weight curtains
- Includes curtain, valance hooks and draw rods
- Straight and bay windows
- Hand bendable
- Wall and ceiling fix brackets

Sizes available: 125cm, 150cm, 175cm, 200cm, 225cm, 250cm, 300cm*, 400cm*
 * Supplied in two halves with joiner

TWINGLYDE

SWN500W0(SIZE)G

Depth of profile: 15mm

Bracket projection: Track: 43mm Valance: 94mm

Retail packaging: Clear acetate

- White pvc
- Suitable for medium weight curtains
- Includes curtain and valance hooks
- Straight and bay windows
- Hand bendable
- Wall and ceiling fix brackets

Sizes available: 125cm, 150cm, 175cm, 200cm, 225cm, 250cm, 275cm



VALANCE

SWL400W0(SIZE)G

Depth of profile: 10mm

Bracket projection: 140mm

Retail packaging: Clear acetate

- White pvc
- Includes hooks
- Straight and bay windows
- Wall and ceiling fix brackets
- Compatible with most tracks

Sizes available: 125cm, 150cm, 200cm, 250cm, 275cm



LASER GLIDE VALANCE

H3043/(SIZE)

Depth of profile: 16mm

Bracket projection: 120mm

Retail packaging: Polythene bag/header card

- White pvc
- Includes hooks
- Straight and bay windows
- Wall and ceiling fix brackets
- Compatible with most tracks

Sizes available: 120cm, 150cm, 180cm, 240cm, 300cm, 360cm

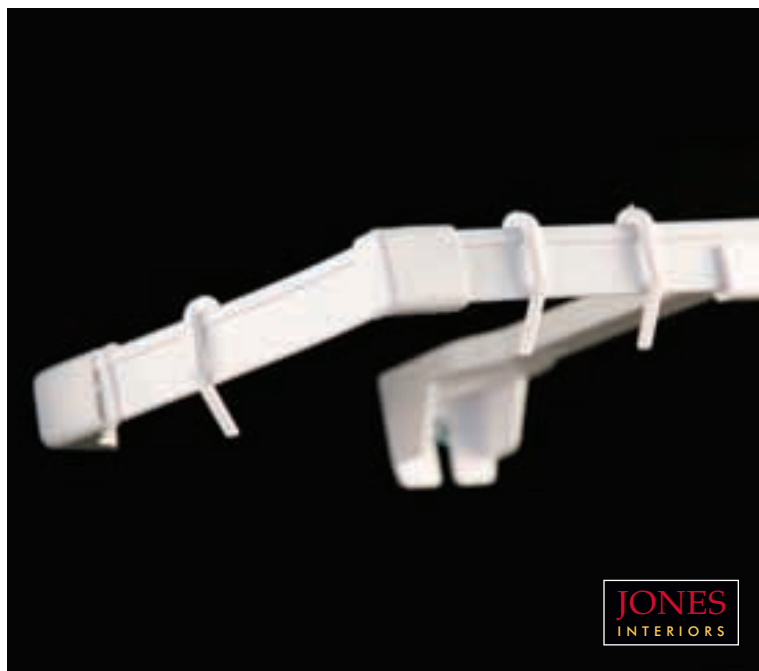

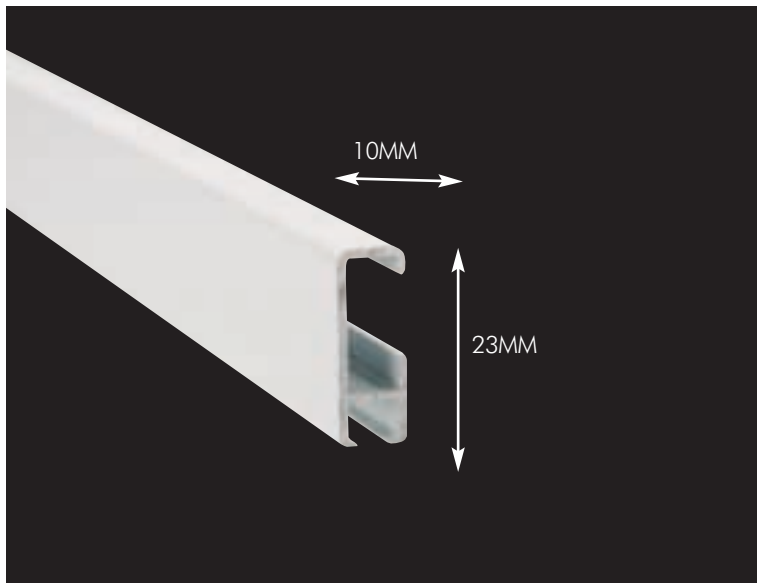

Aluminium 3m (x20)

H772TWS3

Aluminium 6m (x10)

H772TWS6

White powder coated aluminium

Depth of profiles: 23mm

Suitable for medium to heavyweight curtains

- Siliconised gliders
- UV resistant nylon fittings
- Large choice of brackets
- Straight or bay windows using bending tool
- Full range of components ensure these tracks are versatile and easy to install

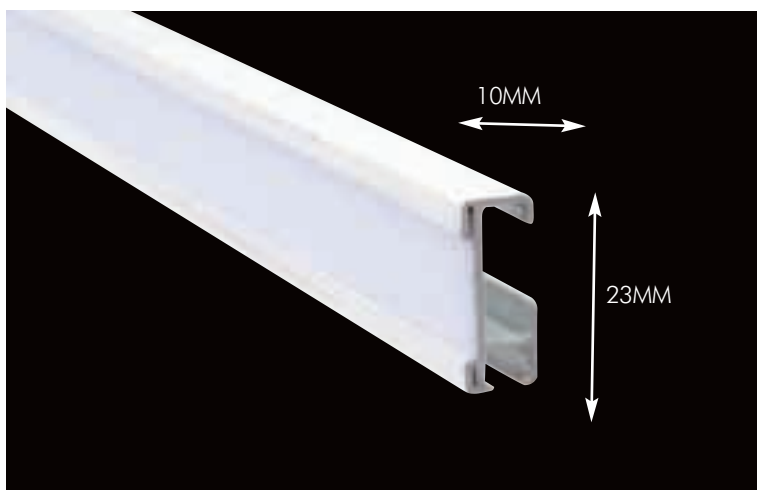

Velcro Faced Profile 3m (x10)

H794TS3

Velcro Faced Profile 6m (x5)

H794TS6

Suitable for Roman, Austrian and Festoon blinds or velour backed pelmets/valances (see drawing).



UNIVERSAL COMPONENTS:

- | | |
|---|------------------|
| 1 LEVER LOCK BRACKET | |
| 3cm, | H772LL/S3 |
| 4cm, | H772LL/S4 |
| 6cm | H772LL/S6 |
| 2 UNIVERSAL BRACKET - 4cm | H772UB |
| 3 CEILING BRACKET | H772CB |
| 4 EASI-FIT BRACKET | |
| 3cm | H772EF/S3 |
| 4cm | H772EF/S4 |
| 5 METAL BRACKET (opposite page for illustration) | H772MB |
| 6 NYLON GLIDERS | H772G |
| 7 END CAP (Curtain Track only) | H772EC |
| 8 TWIST END STOP | H772TE |
| 9 SCREW END STOP | H772SE |
| 10 OVERLAP CARRIER | H772OC |
| 11 JOINING SPLICE | H772J |
| 12 CORD GUIDE | H794CG |
| 13 END CAP (Velcro Track only) | H794EC |
| 14 VALANCE CORNER | H794VC |
| 15 VALANCE WALL SUPPORT | H794VB |

1 Multi-layer Option

This drawing shows our contract components used to create a twin track system. The outer rail is shown as 'Velcro' faced for use with loop back headed valances or pelmets. Please see page 106 for suitable heading tapes and page 118 for suitable pelmet stiffeners. Alternatively this could be made in our standard H772 profile to create a layered curtain installation.

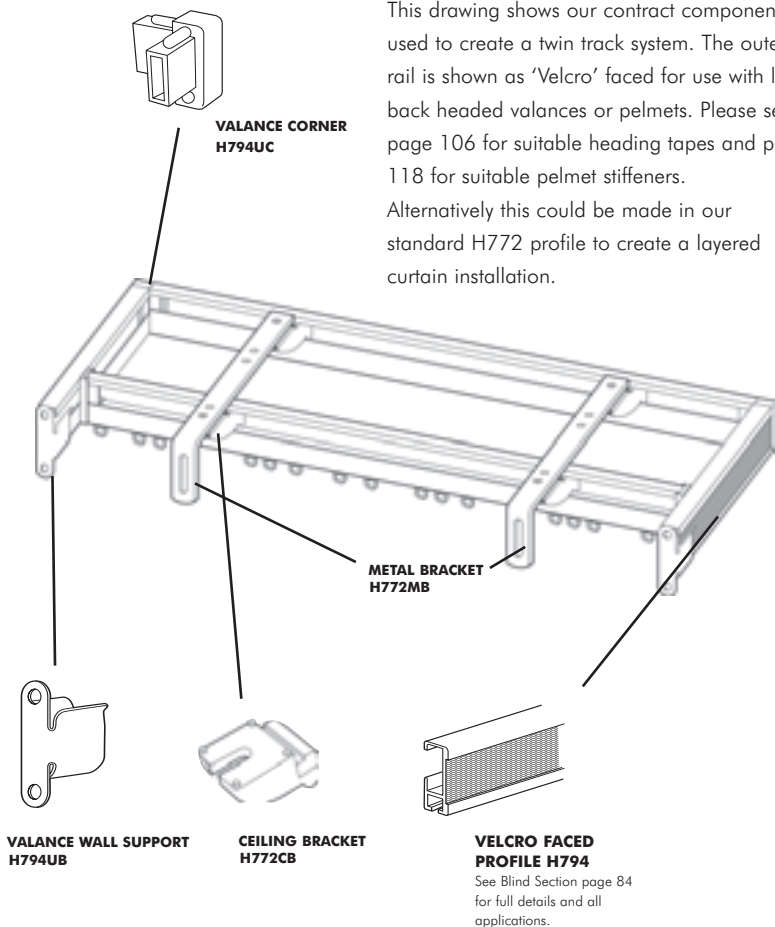

2 BENDING TOOL H772BTX

Essential for accurate bending of either H772 or H794 profiles. This tough, lightweight machine can easily be taken on site if required but does need to be mounted to a suitable work surface. Supplied complete with filler sets.

3 WHITE DRAWING ROD

- 50cm **H321S50**
- 75cm **H321S75**
- 100cm **H321S100**
- 150cm **H321S150**



TRACK ACCESSORIES

SLOTTED PELMET BRACKETS 152 X 122mm
4 WHITE PAINTED **H4035CWHT**
5 ZINC PLATED **H4035CZNC**
 Pack size 20



CENTRE PELMET BRACKETS 152mm
6 ZINC PLATED **H4036CZNC**
7 WHITE PAINTED **H4036CWHT**
 Pack size 20



SLOTTED PELMET BRACKETS 102 X 76mm
8 ZINC PLATED **H1120CZNC**
9 WHITE PAINTED **H1120CWH**
 Pack size 20



CENTRE PELMET BRACKETS 78mm
10 ZINC PLATED **H1121CZNC**
11 WHITE PAINTED **H1121CWHT**
 Pack size 20

12 CAVITY WALL FIXING **H1110**
13 TRACK SPACERS **H1122**



For Track clearance use with Pelmet Brackets.
 Depth: 10mm
 Minimum quantity: 100

14 SILICONE SPRAY **H889**



1 INTEGRA DOUBLE DUTY	I05171/16
2 CURVED MASTER SLIDES	I05013
3 STRAIGHT METAL MASTER SLIDES	I05014/MET
4 PENDULUM SLIDE	I05051
5 BALL BEARING END PULLEY	I05161
6 END BRACKET 62.5 - 87.5mm	I05163
7 SUPPORT 62.5 - 87.5mm	I05165
8 1 SLOT SUPPORT	I05271
9 SPLICE	I05224
10 PLAIN SLIDE	I20083
11 TENSION PULLEY	I20085
12 BALL BEARING INSERT PULLEY	I05276
13 LOCK SLIDE	I05279

Depth of profile: 25mm
 Length of profile: 488cm
 Suitable for heavyweight curtains

- White painted steel
- Pre-notched for bay windows I05172/16 (Not shown) (Rail bending set required)
- Un-notched for straight windows I05171/16
- Silicon enriched gliders I20083 or steel pendulum slides I05051
- Ball bearing end pulleys
- Wall & ceiling fix brackets available.
- Full range of fittings available, see Integra Products Catalogue

14 INTEGRA REGULAR	I05121(SIZE)
15 SUPPORT STIRRUP	I05029
16 SUPPORT 37.5 - 62.5mm	I05080
17 1 SLOT SUPPORT 37.5 - 62.5mm	I05273
18 BALL BEARING END PULLEY	I05077
19 CURVED MASTER SLIDES	I05013
20 STRAIGHT METAL MASTER SLIDES	I05014/MET
21 END BRACKET 37.5 - 62.5mm	I05078
22 PLAIN SLIDE	I20083
23 TENSION PULLEY	I20085
24 BALL BEARING INSERT PULLEY	I05275
25 LOCK SLIDE	I05278
26 SPLICE	I05283

Depth of profile: 19mm
 Length of profile: 244cm, 366cm, 488cm
 Suitable for medium to heavyweight curtains

- White painted steel
- Straight or bay windows using rail bending set
- Silicon enriched gliders I20083 or steel pendulum slides I05051
- Ball bearing end pulleys
- Wall & ceiling fix brackets available.
- Full range of fittings available, see Integra Products Catalogue